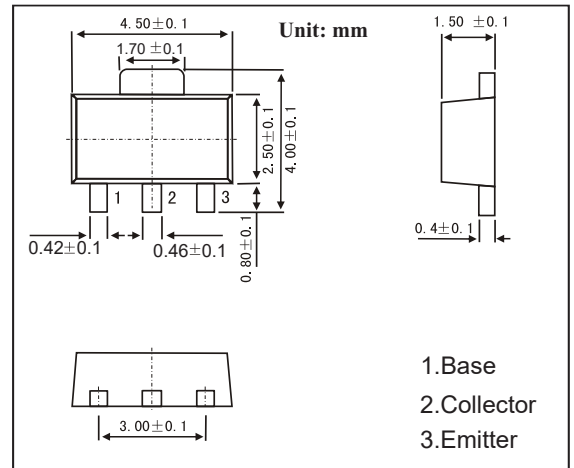

SOT-89 Plastic-Encapsulate Transistors
FEATURES

- High breakdown voltage and high current.
- Low collector-emitter saturation voltage $V_{CE(sat)}$
- Good h_{FE} linearity
- PNP Transistors

MECHANICAL DATA

- Case style: SOT-23 molded plastic
- Mounting position: any

MAXIMUM RATINGS AND CHARACTERISTICS

@ 25°C Ambient Temperature (unless otherwise noted)

Parameter	Symbol	Rating	Unit
Collector - Base Voltage	V_{CBO}	-80	V
Collector - Emitter Voltage	V_{CEO}	-80	
Emitter - Base Voltage	V_{EBO}	-5	
Collector Current - Continuous	I_C	-1	A
Collector current -Pulse	I_{CP}	-2	
Collector Power Dissipation	P_C	0.5	W
		2	
Junction Temperature	T_J	150	°C
Storage Temperature range	T_{stg}	-55 to 150	

Parameter	Symbol	Test Conditions	Min	Typ	Max	Unit
Collector- base breakdown voltage	V_{CBO}	$I_C = -100 \mu A, I_E = 0$	-80			V
Collector- emitter breakdown voltage	V_{CEO}	$I_C = -1 mA, I_B = 0$	-80			
Emitter - base breakdown voltage	V_{EBO}	$I_E = -100 \mu A, I_C = 0$	-5			
Collector-base cut-off current	I_{CBO}	$V_{CB} = -60V, I_E = 0$			-1	uA
Emitter cut-off current	I_{EBO}	$V_{EB} = -4V, I_C = 0$			-1	
Collector-emitter saturation voltage	$V_{CE(sat)}$	$I_C = -500 mA, I_B = -50mA$			-0.4	V
Base - emitter saturation voltage	$V_{BE(sat)}$	$I_C = -500 mA, I_B = -50mA$			-1.2	
DC current gain	h_{FE}	$V_{CE} = -3V, I_C = -100 mA$	120		390	
Collector output capacitance	C_{ob}	$V_{CB} = -10V, I_E = 0, f = 1MHz$		20		pF
Transition frequency	f_T	$V_{CE} = -10V, I_E = 50mA, f = 100MHz$		100		MHz

RATINGS AND CHARACTERISTIC CURVES

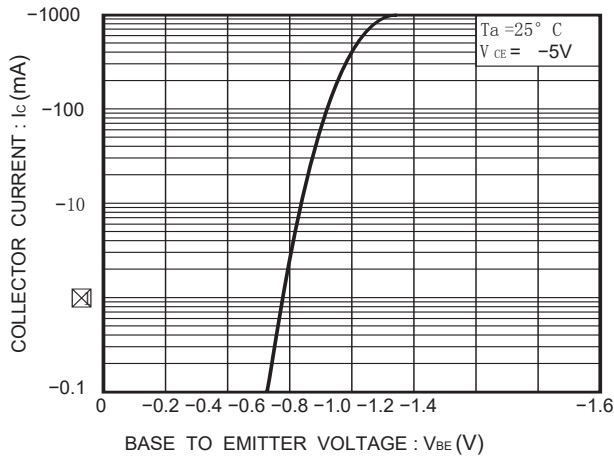

Fig.1 Grounded emitter propagation characteristics

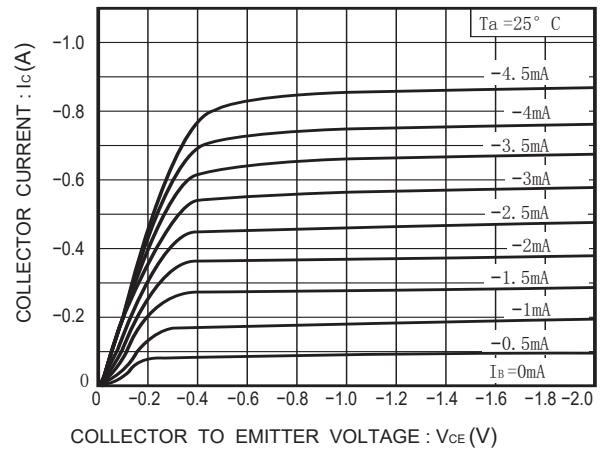

Fig.2 Grounded emitter output characteristics

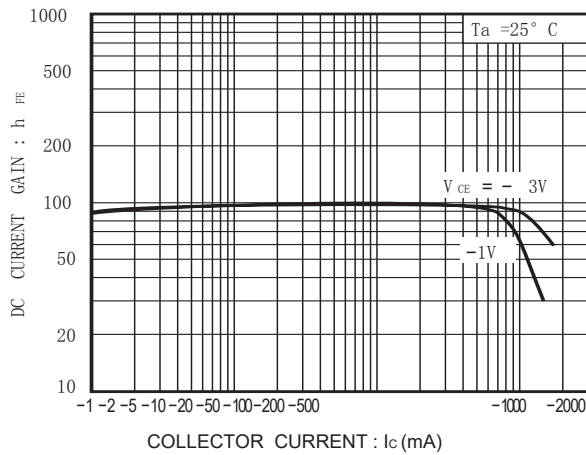

Fig.3 DC current gain vs. collector current

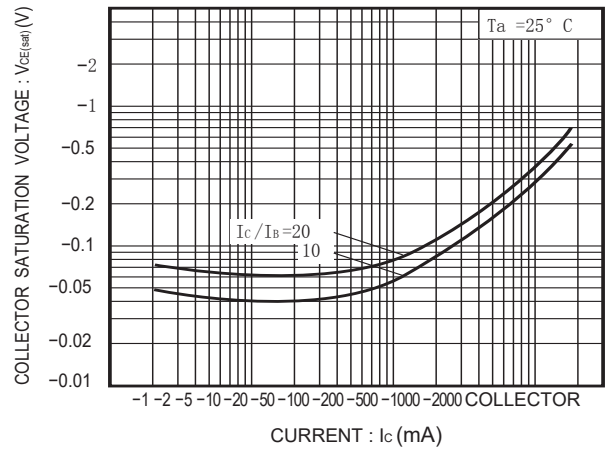

Fig.4 Collector-emitter saturation voltage vs. collector current

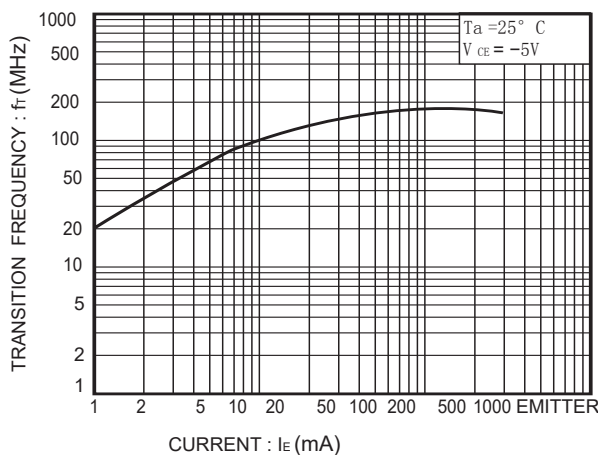

Fig.5 Gain bandwidth product vs. emitter current

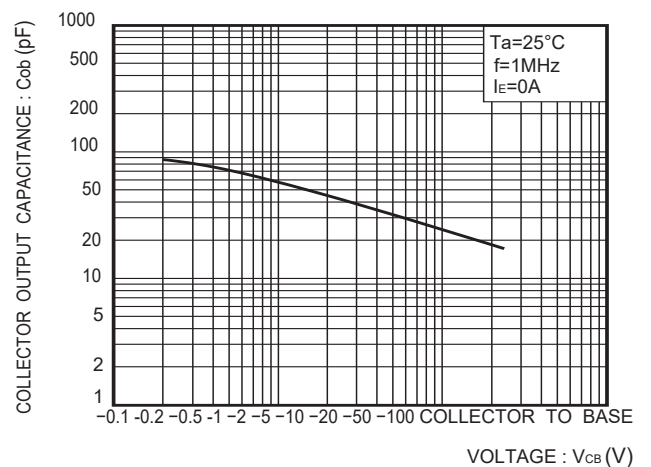

Fig.6 Collector output capacitance vs. collector-base voltage